

THE NEW VALUE FRONTIER



ドリル
Drilling

DRC型

マジックドリル

DRC型

MagicDrill DRC type

高性能モジュラードリル

High efficiency drill module

高能率
High efficiency

高送り
High feed rate

高信頼性
High reliability

高品位
High quality

加工径拡大
Cutting diameter expanded



SS-DRC型
(ストレートシャック型)
Straight Shank

加工径 $\phi 7.94 \sim \phi 25.50$

Machining diameter $\phi 7.94 - \phi 25.50$

加工深さ 3D・5D・8D

Machining depth 3D, 5D, 8D

SF-DRC型 面取りアタッチメント
(フランジ型) Chamfering attachment
for SS-DRC

ADVANCING PRODUCTIVITY

生産性向上に貢献する京セラ

マジックドリルDRC型は4つの 高速、高送りを可能にし、生産性向

4 unique characteristics of DRC type MagicDrills improve productivity as well as reduce machining

1. セルフクランプ構造

Self-Clamping design

- 簡単・確実なセルフクランプ構造によりクランプ剛性と耐久性が飛躍的向上。

The clamp rigidity and resistance of the MagicDrills self-clamping method (self-clamping design) has significantly improved with the new design analysis and material technology.

- マシン上で簡単刃先交換。
Easy replacement is possible on the machine.

直線切れ刃と安定性の高いコーナ
Straight cutting edge and stable corner edge

チップ
Insert

拘束安定
Binding stability



3. マルチヘリカルアングル構造

Multiple Helical Angle Flute design

- 本体の強度アップと切りくず排出をスムーズにしています。
Provides superior drill body stiffness and chip evacuation

4. ダイレクトクーリング構造

Direct Cooling design

- チップのすくい面に直接クーラントが供給され、ドリル先端の冷却と切りくずの溶着防止、速やかな切りくず排出を実現します。

The coolant is fed directly into the inserts cutting face, cooling the top of the drill and preventing chip adhesion, which allows for quick and smooth chip evacuation.



独創的な特長により、 上、加工コスト低減を実現します。

cost by high speed and high feed rate machining.

2.セルフセンタリング構造

Self-Centering design

- セルフセンタリング構造のS字曲線刃先形状は、スムーズな食いつき、低い切削抵抗、良好な穴側面品位を実現します。

The S curve top shape geometry which is called "Self-Centering design" can perform smooth drilling, low cutting force and high quality surface of the hole.

セルフセンタリング構造
Self-Centering design

クーラント穴
Coolant hole



フラットカットが付いたフランジ付タイプ、面取りアタッチメントがラインナップ追加。

旋盤、M/Cなど多様なマシンに対応が可能になりました。

A chamfering attachment have been added to the lineup. It is now possible to accommodate various types of machines, such as lathes and machining centers.



型番の表示方法(チップ) Description Identification System (Inserts)

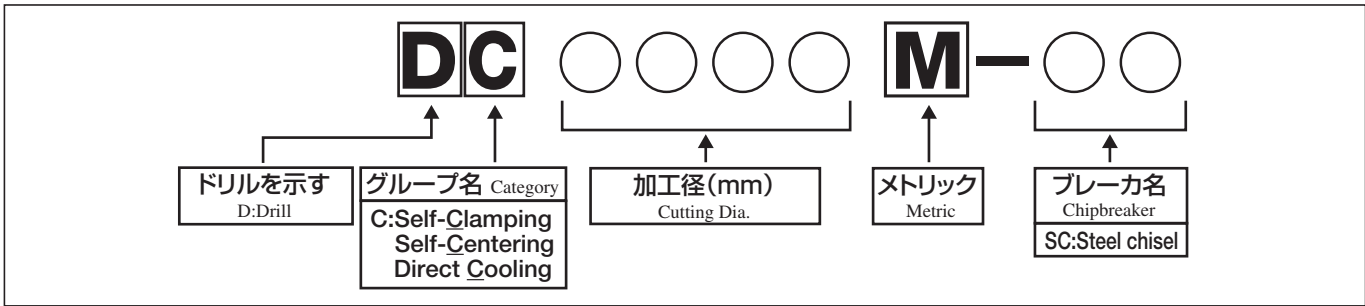

ドリル用チップ Drilling Inserts

●チップ材種 PR0315 Insert grade PR0315

PR0315は強靱性超微粒子超硬にTiAlNコーティングされた、耐摩耗性・耐欠損性共に優れたチップ材種です。炭素鋼・合金鋼～鋳鉄等の幅広い被削材に適応し、安定加工を可能にします。

PR0315 is tough super micro grain carbide grade with TiAlN coating, with excellent wear resistance and fracture resistance. It enables stable machining of carbon steel, alloy steel and cast iron.

形状 Shape	型番 Description	寸法(mm) Dimensions(mm)		PVDコーティング PVD Coated	適合ホルダ型番 Applicable holder description								
		φDc	Lp	PR0315									
<p>140°</p> <p>φDc k8</p> <p>Lp</p> <p>k8公差寸法 k8 tolerance</p> <table border="1"> <thead> <tr> <th>φDc</th> <th>k8(mm)</th> </tr> </thead> <tbody> <tr> <td>7.94 } 10.00</td> <td>+0.022 0</td> </tr> <tr> <td>10.10 } 18.00</td> <td>+0.027 0</td> </tr> <tr> <td>18.10 } 25.50</td> <td>+0.033 0</td> </tr> </tbody> </table> <p>尚、k8はチップ自体の寸法公差です。加工孔径の寸法公差ではありません。k8 is the dimension tolerance of the insert. It is not the dimension tolerance of the cutting diameter.</p>	φDc	k8(mm)	7.94 } 10.00	+0.022 0	10.10 } 18.00	+0.027 0	18.10 } 25.50	+0.033 0	DC 0794M-SC	7.94	1.44	●	SS10-DRC080M-○ SF12-DRC080M-○
	φDc	k8(mm)											
	7.94 } 10.00	+0.022 0											
	10.10 } 18.00	+0.027 0											
	18.10 } 25.50	+0.033 0											
	0800M-SC	8.00	1.46	●									
	0810M-SC	8.10	1.47	●									
	0820M-SC	8.20	1.49	●									
	0830M-SC	8.30	1.51	●									
	0840M-SC	8.40	1.53	●									
	DC 0850M-SC	8.50	1.55	●	SS10-DRC085M-○ SF12-DRC085M-○								
	0860M-SC	8.60	1.56	●									
	0870M-SC	8.70	1.58	●									
	0880M-SC	8.80	1.60	●									
	0890M-SC	8.90	1.62	●									
	DC 0900M-SC	9.00	1.64	●	SS10-DRC090M-○ SF12-DRC090M-○								
	0910M-SC	9.10	1.66	●									
	0920M-SC	9.20	1.67	●									
	0930M-SC	9.30	1.69	●									
	0940M-SC	9.40	1.71	●									
	DC 0950M-SC	9.50	1.73	●	SS10-DRC095M-○ SF12-DRC095M-○								
	0960M-SC	9.60	1.75	●									
	0970M-SC	9.70	1.76	●									
	0980M-SC	9.80	1.78	●									
DC 0990M-SC	9.90	1.80	●	SS12-DRC100M-○ SF16-DRC100M-○									
DC 1000M-SC	10.00	1.82	●										
1010M-SC	10.10	1.84	●										
1020M-SC	10.20	1.86	●										
1030M-SC	10.30	1.87	●										
DC 1040M-SC	10.40	1.89	●	SS12-DRC105M-○ SF16-DRC105M-○									
DC 1050M-SC	10.50	1.91	●										
1060M-SC	10.60	1.93	●										
1070M-SC	10.70	1.95	●										
1080M-SC	10.80	1.96	●										
DC 1090M-SC	10.90	1.98	●	SS12-DRC110M-○ SF16-DRC110M-○									
DC 1100M-SC	11.00	2.00	●										
1110M-SC	11.10	2.02	●										
1120M-SC	11.20	2.04	●										
DC 1130M-SC	11.30	2.06	●	SS12-DRC115M-○ SF16-DRC115M-○									
DC 1140M-SC	11.40	2.07	●										
DC 1150M-SC	11.50	2.09	●										
1160M-SC	11.60	2.11	●										
1170M-SC	11.70	2.13	●										
DC 1180M-SC	11.80	2.15	●	SS14-DRC120M-○ SF16-DRC120M-○									
DC 1190M-SC	11.90	2.16	●										
DC 1200M-SC	12.00	2.18	●										
1210M-SC	12.10	2.20	●										
1220M-SC	12.20	2.22	●										
DC 1230M-SC	12.30	2.24	●										
DC 1240M-SC	12.40	2.26	●										

●:標準在庫 ●:Std stock

ドリル用チップ Drilling Inserts

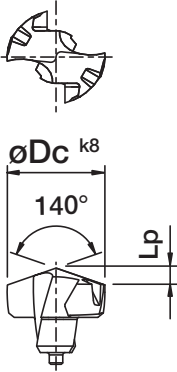
形状 Shape	型番 Description	寸法(mm) Dimensions(mm)		PVDコーティング PVD Coated	適合ホルダ型番 Applicable holder description
		φDc	Lp	PR0315	
 	DC 1250M-SC	12.50	2.27	●	SS14-DRC125M-○ SF16-DRC125M-○
	1260M-SC	12.60	2.29	●	
	1270M-SC	12.70	2.31	●	
	1280M-SC	12.80	2.33	●	
	1290M-SC	12.90	2.35	●	
	DC 1300M-SC	13.00	2.36	●	SS14-DRC130M-○ SF16-DRC130M-○
	1310M-SC	13.10	2.38	●	
	1320M-SC	13.20	2.40	●	
	1330M-SC	13.30	2.42	●	
	1340M-SC	13.40	2.44	●	
	DC 1350M-SC	13.50	2.46	●	SS14-DRC135M-○ SF16-DRC135M-○
	1360M-SC	13.60	2.47	●	
	1370M-SC	13.70	2.49	●	
	1380M-SC	13.80	2.51	●	
	DC 1390M-SC	13.90	2.53	●	
	DC 1400M-SC	14.00	2.55	●	SS16-DRC140M-○ SF16-DRC140M-○
	1410M-SC	14.10	2.56	●	
	1420M-SC	14.20	2.58	●	
	1430M-SC	14.30	2.60	●	
	1440M-SC	14.40	2.62	●	
	DC 1450M-SC	14.50	2.64	●	SS16-DRC145M-○ SF16-DRC145M-○
	1460M-SC	14.60	2.66	●	
	1470M-SC	14.70	2.67	●	
	1480M-SC	14.80	2.69	●	
	1490M-SC	14.90	2.71	●	
	DC 1500M-SC	15.00	2.73	●	SS16-DRC150M-○ SF20-DRC150M-○
	1510M-SC	15.10	2.75	●	
	1520M-SC	15.20	2.76	●	
	1530M-SC	15.30	2.78	●	
	1540M-SC	15.40	2.80	●	
	1550M-SC	15.50	2.82	●	
	1560M-SC	15.60	2.84	●	
	1570M-SC	15.70	2.86	●	
	1580M-SC	15.80	2.87	●	
	1590M-SC	15.90	2.89	●	
	DC 1600M-SC	16.00	2.91	●	SS18-DRC160M-○ SF20-DRC160M-○
	1610M-SC	16.10	2.93	●	
	1620M-SC	16.20	2.95	●	
	1630M-SC	16.30	2.96	●	
	1640M-SC	16.40	2.98	●	
	1650M-SC	16.50	3.00	●	
	1660M-SC	16.60	3.02	●	
	1670M-SC	16.70	3.04	●	
	1680M-SC	16.80	3.06	●	
	1690M-SC	16.90	3.07	●	
DC 1700M-SC	17.00	3.09	●	SS18-DRC170M-○ SF20-DRC170M-○	
1710M-SC	17.10	3.11	●		
1720M-SC	17.20	3.13	●		
1730M-SC	17.30	3.15	●		
1740M-SC	17.40	3.16	●		
1750M-SC	17.50	3.18	●		
1760M-SC	17.60	3.20	●		
1770M-SC	17.70	3.22	●		
1780M-SC	17.80	3.24	●		
1790M-SC	17.90	3.26	●		
DC 1800M-SC	18.00	3.27	●	SS20-DRC180M-○ SF25-DRC180M-○	
1810M-SC	18.10	3.29	●		
1820M-SC	18.20	3.31	●		
1830M-SC	18.30	3.33	●		
1840M-SC	18.40	3.35	●		
1850M-SC	18.50	3.36	●		
1860M-SC	18.60	3.38	●		
1870M-SC	18.70	3.40	●		
1880M-SC	18.80	3.42	●		
1890M-SC	18.90	3.44	●		

k8公差寸法 k8 tolerance

φDc	k8 (mm)
7.94 } 10.00	+0.022 0
10.10 } 18.00	+0.027 0
18.10 } 25.50	+0.033 0

尚、k8はチップ自体の寸法公差です。加工穴径の寸法公差ではありません。
k8 is the dimension tolerance of the insert.
It is not the dimension tolerance of the cutting diameter.

チップの販売個数は1ケース1個入りです。Insert is sold in 1 piece per 1 box.

●:標準在庫 ●:Std stock

■ドリル用チップ Drilling Inserts

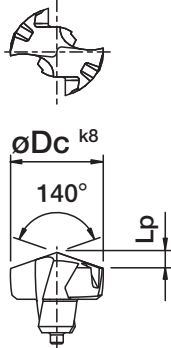
形状 Shape	型番 Description	寸法(mm) Dimensions(mm)		PVDコーティング PVD Coated	適合ホルダ型番 Applicable holder description
		φDc	Lp	PR0315	
 	DC 1900M-SC	19.00	3.46	●	SS20-DRC190M-○ SF25-DRC190M-○
	1910M-SC	19.10	3.47	●	
	1920M-SC	19.20	3.49	●	
	1930M-SC	19.30	3.51	●	
	1940M-SC	19.40	3.53	●	
	1950M-SC	19.50	3.55	●	
	1960M-SC	19.60	3.56	●	
	1970M-SC	19.70	3.58	●	
	1980M-SC	19.80	3.60	●	
	1990M-SC	19.90	3.62	●	
	DC 2000M-SC	20.00	3.64	●	SS25-DRC200M-○ SF25-DRC200M-○
	2010M-SC	20.10	3.66	●	
	2020M-SC	20.20	3.67	●	
	2030M-SC	20.30	3.69	●	
	2040M-SC	20.40	3.71	●	
	2050M-SC	20.50	3.73	●	
	2060M-SC	20.60	3.75	●	
	2070M-SC	20.70	3.77	●	
	2080M-SC	20.80	3.78	●	
	2090M-SC	20.90	3.80	●	
	2099M-SC	20.99	3.82	●	
	DC 2100M-SC	21.00	3.82	●	SS25-DRC210M-○ SF25-DRC210M-○
	2150M-SC	21.50	3.91	●	
	2200M-SC	22.00	4.00	●	SS25-DRC220M-○ SF25-DRC220M-○
	2250M-SC	22.50	4.09	●	
	2300M-SC	23.00	4.18	●	SS25-DRC230M-○ SF25-DRC230M-○
	2350M-SC	23.50	4.27	●	
	2400M-SC	24.00	4.37	●	SS25-DRC240M-○ SF25-DRC240M-○
	2450M-SC	24.50	4.46	●	
	2500M-SC	25.00	4.55	●	SS32-DRC250M-○ SF25-DRC250M-○
2550M-SC	25.50	4.64	●		

k8公差寸法 k8 tolerance

φDc	k8(mm)
7.94 10.00	+0.022 0
10.10 18.00	+0.027 0
18.10 25.50	+0.033 0

尚、k8はチップ自体の寸法公差です。
加工穴径の寸法公差ではありません。
k8 is the dimension tolerance of the insert.
It is not the dimension tolerance of the cutting diameter.

チップの販売個数は1ケース1個入りです。Insert is sold in 1 piece per 1 box.

●:標準在庫 ●:Std stock

Q&A

Q-1 再研磨は出来ますか? Is re-grinding available?

A-1 推奨致しません。
チップ先端のチゼル部再成研磨が難しい為です。
We don't recommend it. Grinding of edge nose chisel is not possible.

Q-2 加工穴はチップ加工径(φDc)に対し、どの程度大きくなりますか?
How large would the cutting hole be to the insert diameter (φDc)?

A-2 SCM435の加工で、チップ加工径(φDc)に対し+0.020~+0.040mm程度大きくなります。
The machining hole with SCM 435, compare to the insert diameter, is about +0.020~+0.040mm.

型番の表示方法(ホルダ) Description Identification System (Toolholder Dimension)

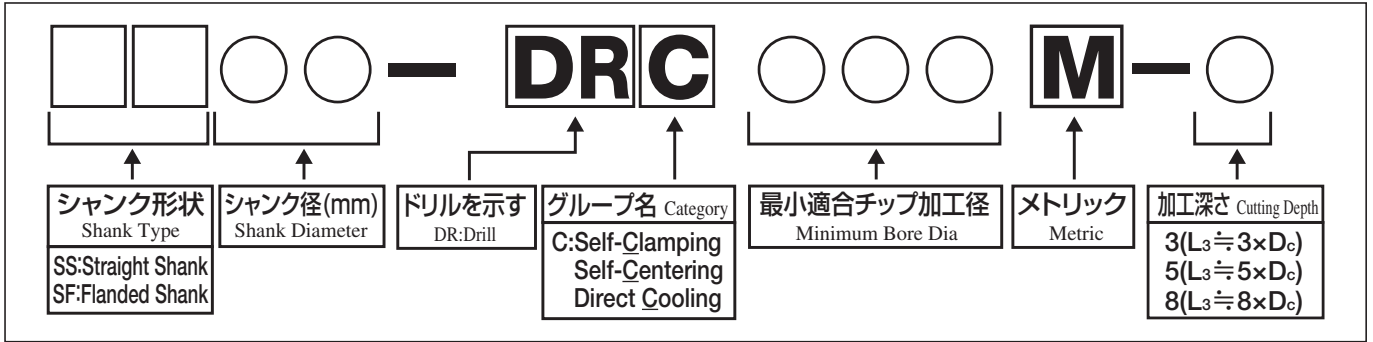

SS-DRC型(加工深さ Cutting Depth: 3×D)

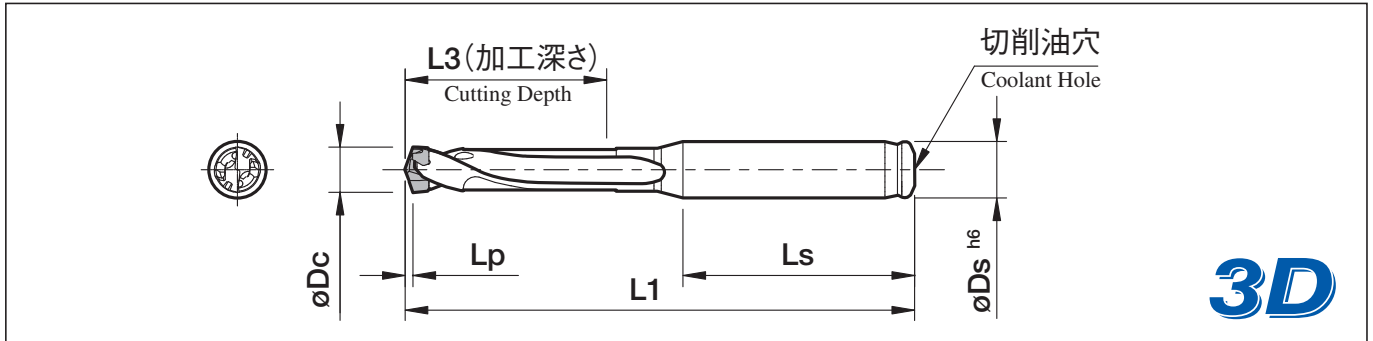

・Lp 寸法はチップ先端からコーナまでの距離を示す P3 ~ P5 参照 Lp indicates distance from drill point to corner edge See P3-P5

ホルダ寸法 Toolholder Dimension

型番 Description	在庫 stock	寸法(mm) Dimensions(mm)					部品 Spare Parts チップ交換レンチ Wrench P14参照 See P14	適合チップ型番 Applicable Insert description	適合面取り型番 Applicable chamfering Holder and Insert description		
		適合チップサイズ ϕD_c Applicable Insert Dia.		ϕD_s (h6)	L1	L3			Ls	ホルダ Holder	チップ Insert
		min.	max.								
SS10- DRC080M-3	●	7.94	8.49	10	79	25.5	40	WDRC8 (WDRC17)	S20-CH10	CT08T2-45A	
	●	8.50	8.99		81	27.0					
	●	9.00	9.49		83	28.5					
	●	9.50	9.99		85	30.0					
SS12- DRC100M-3	●	10.00	10.49	12	92	31.5	45	WDRC10 (WDRC17)	S32-CH12	CT12T3-45A	
	●	10.50	10.99		94	33.0					
	●	11.00	11.49		96	34.5					
	●	11.50	11.99		98	36.0					
SS14- DRC120M-3	●	12.00	12.49	14	101	37.5	48	WDRC12 (WDRC17)	S32-CH14	CT12T3-45A	
	●	12.50	12.99		103	39.0					
	●	13.00	13.49		105	40.5					
	●	13.50	13.99		107	42.0					
SS16- DRC140M-3	●	14.00	14.49	16	112	43.5	51	WDRC14 (WDRC17)	S32-CH16	-	
	●	14.50	14.99		114	45.0					
	●	15.00	15.99		118	48.0					
SS18- DRC160M-3	●	16.00	16.99	18	122	51.0	56	WDRC17	S32-CH18	-	
	●	17.00	17.99		127	54.0					
SS20- DRC180M-3	●	18.00	18.99	20	133	57.0	60	-	-	-	
	●	19.00	19.99		137	60.0					
SS25- DRC200M-3	●	20.00	20.99	25	147	63.0	60	-	-	-	
	●	21.00	21.99		151	66.0					
	●	22.00	22.99		156	69.0					
	●	23.00	23.99		160	72.0					
	●	24.00	24.99		164	75.0					
SS32- DRC250M-3	●	25.00	25.50	32	172	78.0	60	-	-	-	

●:標準在庫 ●:Std stock

SS-DRC型(加工深さ Cutting Depth: 5×D)

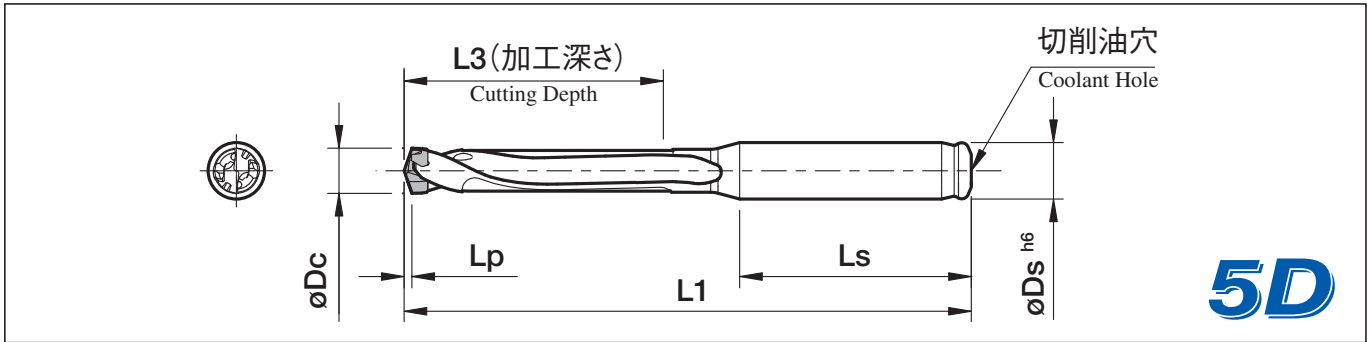

・Lp 寸法はチップ先端からコーナまでの距離を示す P3 ~ P5 参照 Lp indicates distance from drill point to corner edge See P3-P5

ホルダ寸法 Toolholder Dimension

型番 Description	在庫 stock	寸法(mm) Dimensions(mm)						部品 Spare Parts チップ交換レンチ Wrench P14参照 See P14	適合チップ型番 Applicable Insert description	適合面取り型番 Applicable chamfering Holder and Insert description	
		適合チップサイズ øDc Applicable Insert Dia.		øDs (h6)	L1	L3	Ls			ホルダ Holder	チップ Insert
		min.	max.								
SS10- DRC080M-5	●	7.94	8.49	10	97	42.5	40	WDRC8 (WDRC17)	DC0794M-SC~DC0840M-SC	S20-CH10	CT08T2-45A
	●	8.50	8.99		100	45.0			DC0850M-SC~DC0890M-SC		
	●	9.00	9.49		103	47.5			DC0900M-SC~DC0940M-SC		
	●	9.50	9.99		107	50.0			DC0950M-SC~DC0990M-SC		
SS12- DRC100M-5	●	10.00	10.49	12	115	52.5	45	WDRC10 (WDRC17)	DC1000M-SC~DC1040M-SC	S32-CH12	
	●	10.50	10.99		118	55.0			DC1050M-SC~DC1090M-SC		
	●	11.00	11.49		121	57.5			DC1100M-SC~DC1140M-SC		
	●	11.50	11.99		124	60.0			DC1150M-SC~DC1190M-SC		
SS14- DRC120M-5	●	12.00	12.49	14	127	62.5	48	WDRC12 (WDRC17)	DC1200M-SC~DC1240M-SC	S32-CH14	CT12T3-45A
	●	12.50	12.99		130	65.0			DC1250M-SC~DC1290M-SC		
	●	13.00	13.49		133	67.5			DC1300M-SC~DC1340M-SC		
	●	13.50	13.99		137	70.0			DC1350M-SC~DC1390M-SC		
SS16- DRC140M-5	●	14.00	14.49	16	143	72.5	49	WDRC14 (WDRC17)	DC1400M-SC~DC1440M-SC	S32-CH16	
	●	14.50	14.99		146	75.0			DC1450M-SC~DC1490M-SC		
	●	15.00	15.99		152	80.0			DC1500M-SC~DC1580M-SC		
SS18- DRC160M-5	●	16.00	16.99	18	158	85.0	51		DC1600M-SC~DC1690M-SC	S32-CH18	
	●	17.00	17.99		165	90.0			DC1700M-SC~DC1790M-SC		
SS20- DRC180M-5	●	18.00	18.99	20	173	95.0	56	WDRC17	DC1800M-SC~DC1890M-SC		
	●	19.00	19.99		179	100.0			DC1900M-SC~DC1990M-SC		
SS25- DRC200M-5	●	20.00	20.99	25	191	105.0	60		DC2000M-SC~DC2099M-SC		
	●	21.00	21.99		198	110.0			DC2100M-SC~DC2150M-SC		
	●	22.00	22.99		204	115.0			DC2200M-SC~DC2250M-SC		
	●	23.00	23.99		210	120.0			DC2300M-SC~DC2350M-SC		
	●	24.00	24.99		216	125.0			DC2400M-SC~DC2450M-SC		
SS32- DRC250M-5	●	25.00	25.50	32	227	130.0	60		DC2500M-SC~DC2550M-SC		

●:標準在庫 ●:Std stock

SS-DRC型(加工深さ Cutting Depth:8×D)

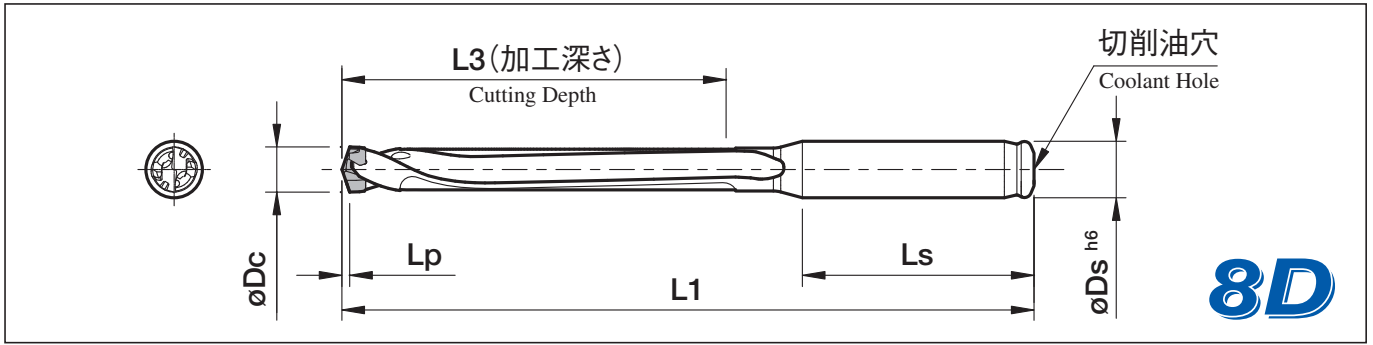

・Lp 寸法はチップ先端からコーナまでの距離を示す P3 ~ P5 参照 Lp indicates distance from drill point to corner edge See P3-P5

ホルダ寸法 Toolholder Dimension

型番 Description	在庫 stock	寸法(mm) Dimensions(mm)					部品 Spare Parts	適合チップ型番 Applicable Insert description	適合面取り型番 Applicable chamfering Holder and Insert description		
		適合チップサイズ øDc Applicable Insert Dia.		øDs (h6)	L1	L3			Ls	ホルダ Holder	チップ Insert
		min.	max.								
SS10- DRC080M-8	●	7.94	8.49	10	122.5	68	40	WDRC8 (WDRC17)	S20-CH10	CT08T2-45A	
	●	8.50	8.99		127.0	72					
	●	9.00	9.49		131.5	76					
	●	9.50	9.99		137.0	80					
SS12- DRC100M-8	●	10.00	10.49	12	146.5	84	45	WDRC10 (WDRC17)	S32-CH12	CT12T3-45A	
	●	10.50	10.99		151.0	88					
	●	11.00	11.49		155.5	92					
	●	11.50	11.99		160.0	96					
SS14- DRC120M-8	●	12.00	12.49	14	164.5	100	48	WDRC12 (WDRC17)	S32-CH14	CT12T3-45A	
	●	12.50	12.99		169.0	104					
	●	13.00	13.49		173.5	108					
	●	13.50	13.99		179.0	112					
SS16- DRC140M-8	●	14.00	14.49	16	186.5	116	49	WDRC14 (WDRC17)	S32-CH16	CT16T3-45A	
	●	14.50	14.99		191.0	120					
	●	15.00	15.99		200.0	128					
SS18- DRC160M-8	●	16.00	16.99	18	209.0	136	50	WDRC16 (WDRC17)	S32-CH18	CT18T3-45A	
	●	17.00	17.99		219.0	144					
SS20- DRC180M-8	●	18.00	18.99	20	230.0	152	51	WDRC18 (WDRC17)	S32-CH20	CT20T3-45A	
	●	19.00	19.99		239.0	160					
SS25- DRC200M-8	●	20.00	20.99	25	254.0	168	56	WDRC17	-	-	
	●	21.00	21.99		264.0	176					
	●	22.00	22.99		273.0	184					
	●	23.00	23.99		282.0	192					
	●	24.00	24.99		291.0	200					
SS32- DRC250M-8	●	25.00	25.50	32	305.0	208	60	WDRC17	-	-	

●:標準在庫 ●:Std stock

●穴あけ・面取り同時加工 Drilling and chamfering in parallel

SS-DRC型は、面取りアタッチメント使用により穴あけ・面取り同時加工が可能になります。

By using the chamfering attachment, the SS-DRC type can now perform drilling and chamfering in parallel.



面取りアタッチメントの詳細はP9～P10をご覧ください。

Please refer to pages 9 and 10 for details on the chamfering attachment

●ホルダ Toolholder

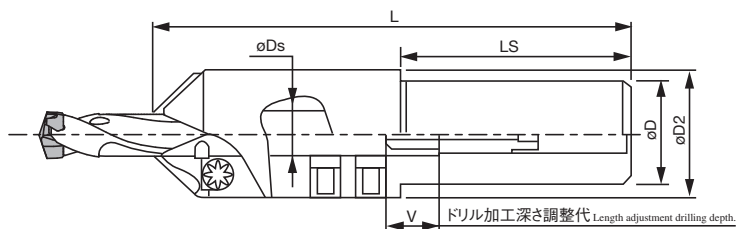

型番 Description	在庫 stock	適合シャック径 ϕD_s Applicable Drill Dia.	寸法(mm) Dimensions(mm)					適合チップ Applicable insert
			ϕD	ϕD_2	L	LS	V	
S20-CH10	●	10	20	29	122	52	17	CT08T2-45A
S32-CH12	●	12	32	38	133	62	21	CT12T3-45A
S32-CH14	●	14		40	137		16	
S32-CH16	●	16		42	141		19	
S32-CH18	●	18		47	144		15	

注) 面取りアタッチメントはストレートシャックSS-DRC型専用です。
フランジ付シャックSF-DRC型には、ご使用出来ません。

Note) Chamfering attachment is dedicated for Straight Shank SS-DRC type.
It cannot be used for Flanged Shank SF-DRC type.

●:標準在庫 ●:Std stock

●ドリル加工深さ・面取り寸法 Drilling depth and chamfering length

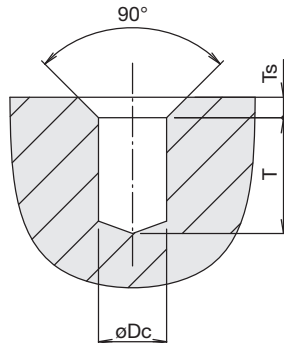

加工径(mm) Cutting Dia.		ドリル加工深さ(mm) Drilling depth						面取り寸法(mm) Chamfering dimension		適合面取りホルダ Applicable toolholder
ϕD_c		T(3Dドリル)		T(5Dドリル)		T(8Dドリル)		Ts		
min	max	min	max	min	max	min	max	Ts 100	Ts max	
$\phi 7.94$	$\phi 8.49$	11	19	21	37	47	63	2.5	5.0	S20-CH10
$\phi 8.50$	$\phi 8.99$	12	21	24	40	51	67			
$\phi 9.00$	$\phi 9.49$	12	23	27	43	56	72			
$\phi 9.50$	$\phi 9.99$	13	25	31	47	61	77			
$\phi 10.00$	$\phi 10.49$	13	26	28	49	60	81	3.5	7.0	S32-CH12
$\phi 10.50$	$\phi 10.99$	14	28	31	52	64	85			
$\phi 11.00$	$\phi 11.49$	14	30	34	55	69	90			
$\phi 11.50$	$\phi 11.99$	15	32	37	58	73	94			
$\phi 12.00$	$\phi 12.49$	15	30	41	56	79	94	4.0	8.0	S32-CH14
$\phi 12.50$	$\phi 12.99$	17	32	44	59	83	96			
$\phi 13.00$	$\phi 13.49$	19	34	47	62	88	103			
$\phi 13.50$	$\phi 13.99$	21	36	51	66	93	108			
$\phi 14.00$	$\phi 14.49$	19	37	50	68	94	112	4.0	8.0	S32-CH16
$\phi 14.50$	$\phi 14.99$	21	39	53	71	98	116			
$\phi 15.00$	$\phi 15.99$	25	43	59	77	107	125	4.0	8.0	S32-CH18
$\phi 16.00$	$\phi 16.99$	30	44	66	80	117	131			
$\phi 17.00$	$\phi 17.99$	35	49	73	87	127	141			

Ts 100:送り最大の場合の最大面取り長さ Ts 100:Max chamfering dimension at the full feed.

Ts max:送り50%ダウンした場合の最大面取り長さ Ts max:Max chamfering dimension at a 50% feed reduction.
(それぞれ、ノンステップで加工可能な最大面取り長さ) (Maximum chamfering length by non step machining)

● 適合チップ Applicable insert

形状 Shape	型番 Description	寸法(mm) Dimensions(mm)		PVDコーティング PVD Coated	適合面取りホルダ Applicable toolholder
		W1	T	PR0315	
	CT08T2-45A	8	2.83	●	S20-CH10
	CT12T3-45A	12	3.98	●	S32-CH12 ? S32-CH18

チップの販売個数は1ケース10個入りです。Inserts are sold in 10 piece per 1 box. ●:標準在庫 ●:Std stock

● 取付け方法 Method to use DRC chamfering attachment

1. ドリル加工深さ調整 Drilling depth adjustment

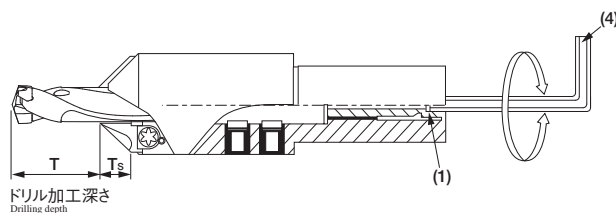

- ドリルを面取りアタッチメント本体に挿入。
- その後、面取りチップAを仮止めする。
- 調整ねじ(1)を六角レンチ(4)で回し、ドリル加工深さTを調整する。
- Insert drill into chamfering attachment.
- Next, temporarily attach the chamfering insert A.
- Turn the adjusting screw (1) with the hexagon wrench (4) to set the drilling depth T.

2. ドリルのセット位置確認 Drill location check

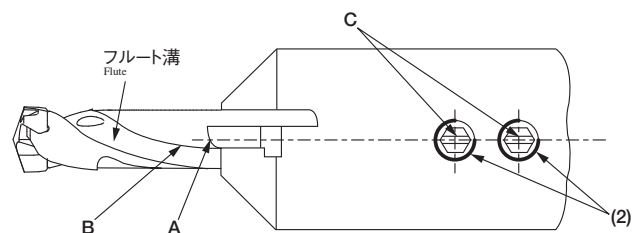

- 面取りチップAがドリルの二番取り面Bに重なる位置までドリルを手で回す。
- ドリル固定ねじ(2)に組み込まれている押さえ金具の溝Cが、上図のように中心線と一直線に並ぶようにセットされていることを確認する。
- Rotate the drill so that the lower end of the chamfering insert A is aligned with the body clearance B of the drill.
- Set it so that slot C in the drill fitting screw (2) is lined up as shown in the figure above.

3. ドリルの固定 Fix the drill

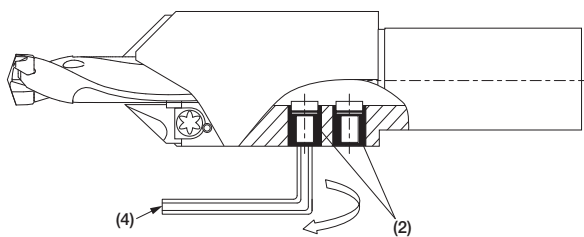

- ドリル固定ねじ(2)を、六角レンチ(4)で締付ける。(トルクレンチをご使用の際は、下表の締付トルクをご参照下さい。)
- Tighten the drill fitting screw (2) with the hexagon wrench (4). (In case of using torque wrench, then please refer below table.)

4. 面取りチップの取付け Installation of the chamfering insert

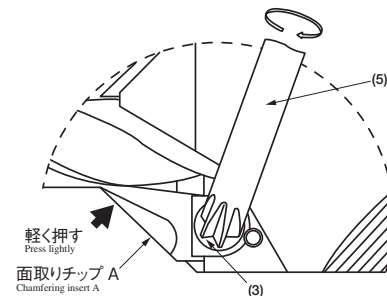

- 面取りチップAをドリルに軽く押し付け、チップ取付けねじ(3)をレンチ(5)で固定する。
- Press the chamfering insert A lightly into the drill and tighten the insert mounting screw (3) with wrench (5).

面取りアタッチメント Chamfering attachment	締付トルク Torque [Nm]	調整ねじ(1) Adjusting screw	ドリル締結ねじ(2) Drill fitting screw	チップ取付けねじ(3) Insert mounting screw	六角レンチ(4) Hexagon wrench	レンチ(5) wrench
S20-CH10	10	AJ-6×38	FS-10	MT-3	LW-3	DT-9
S32-CH12	15	AJ-8×44-9.5	FS-12	MT-4		LW-4
S32-CH14	20	AJ-10×46	FS-14			
S32-CH16	30		FS-16			
S32-CH18	45		FS-18		LW-5	

SF-DRC型(加工深さ Cutting Depth:3×D)

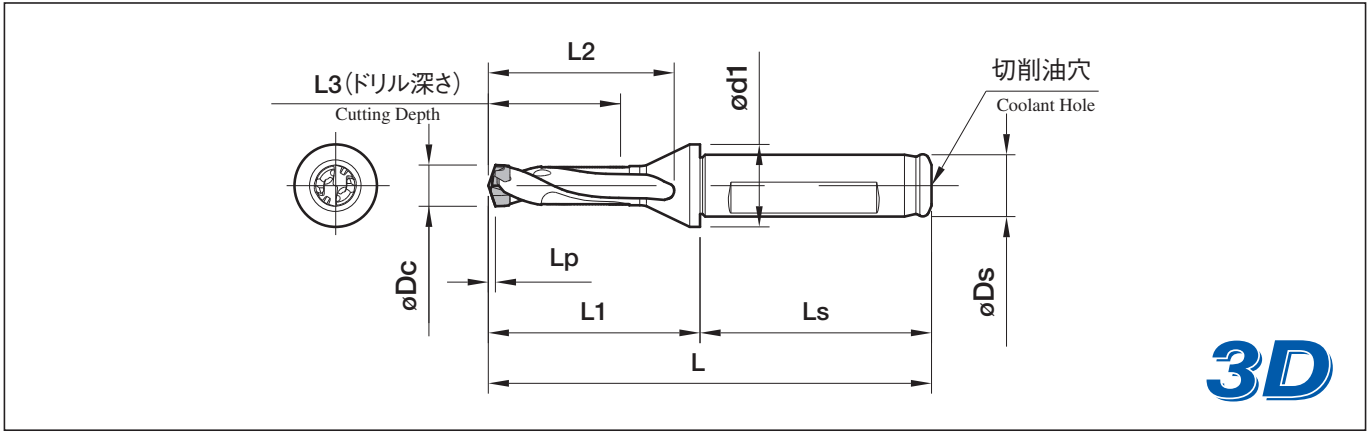

・Lp 寸法はチップ先端からコーナまでの距離を示す P3 ~ P5 参照 Lp indicates distance from drill point to corner edge See P3-P5

ホルダ寸法 Toolholder Dimension

型番 Description	在庫 stock	寸法(mm) Dimensions(mm)									部品 Spare Parts		適合チップ Applicable insert
		適合チップサイズ øDc Applicable Insert Dia.		øDs (h6)	L	L1	L2	L3	Ls	ød1	チップ交換レンチ Wrench P14参照 See P14		
		min.	max.										
SF12- DRC080M-3	●	7.94	8.49	12	86	41	35	26	45	16	WDRC8 (WDRC17)	DC0794M-SC~DC0840M-SC	
	●	8.50	8.99		88	43	37	27				DC0850M-SC~DC0890M-SC	
	●	9.00	9.49		90	45	39	29				DC0900M-SC~DC0940M-SC	
	●	9.50	9.99		92	47	41	30				DC0950M-SC~DC0990M-SC	
SF16- DRC100M-3	●	10.00	10.49	16	97	49	43	32	48	20	WDRC10 (WDRC17)	DC1000M-SC~DC1040M-SC	
	●	10.50	10.99		99	51	45	33				DC1050M-SC~DC1090M-SC	
	●	11.00	11.49		101	53	47	35				DC1100M-SC~DC1140M-SC	
	●	11.50	11.99		103	55	49	36				DC1150M-SC~DC1190M-SC	
	●	12.00	12.49		106	58	52	38			WDRC12 (WDRC17)	DC1200M-SC~DC1240M-SC	
	●	12.50	12.99		108	60	54	39				DC1250M-SC~DC1290M-SC	
	●	13.00	13.49		110	62	56	41				DC1300M-SC~DC1340M-SC	
	●	13.50	13.99		112	64	58	42				DC1350M-SC~DC1390M-SC	
	●	14.00	14.49		114	66	60	44				WDRC14 (WDRC17)	DC1400M-SC~DC1440M-SC
	●	14.50	14.99		116	68	62	45					DC1450M-SC~DC1490M-SC
SF20- DRC150M-3	●	15.00	15.99	20	122	72	66	48	50	25	WDRC14 (WDRC17)	DC1500M-SC~DC1580M-SC	
	●	16.00	16.99		126	76	70	51				DC1600M-SC~DC1690M-SC	
	●	17.00	17.99		131	81	75	54				DC1700M-SC~DC1790M-SC	
SF25- DRC180M-3	●	18.00	18.99	25	141	85	79	57	56	32	WDRC17	DC1800M-SC~DC1890M-SC	
	●	19.00	19.99		145	89	83	60				DC1900M-SC~DC1990M-SC	
	●	20.00	20.99		149	93	87	63				DC2000M-SC~DC2099M-SC	
	●	21.00	21.99		153	97	91	66				DC2100M-SC~DC2150M-SC	
	●	22.00	22.99		158	102	96	69				DC2200M-SC~DC2250M-SC	
	●	23.00	23.99		162	106	100	72				DC2300M-SC~DC2350M-SC	
	●	24.00	24.99		166	110	104	75				DC2400M-SC~DC2450M-SC	
	●	25.00	25.50		170	114	108	78				DC2500M-SC~DC2550M-SC	

●:標準在庫 ●:Std stock

SF-DRC型(加工深さ Cutting Depth:5XD)

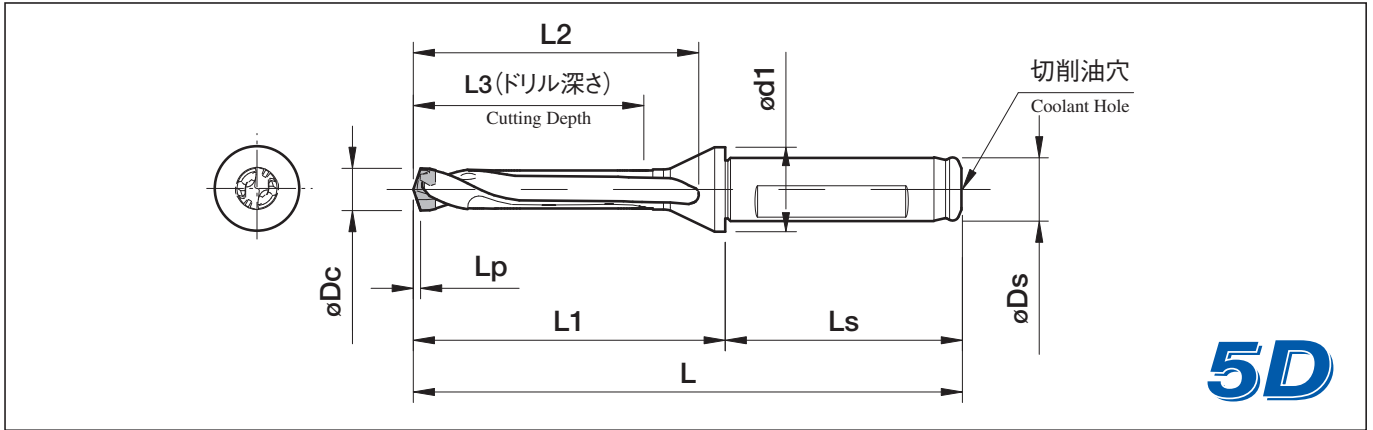

・ Lp 寸法はチップ先端からコーナまでの距離を示す ● P3 ~ P5 参照 Lp indicates distance from drill point to corner edge ● See P3-P5

●ホルダ寸法 Toolholder Dimension

型番 Description	在庫 stock	寸法(mm) Dimensions(mm)								部品 Spare Parts チップ交換レンチ Wrench ● P14参照 See P14	適合チップ Applicable insert		
		適合チップサイズ øDc Applicable Insert Dia.		øDs (h6)	L	L1	L2	L3	Ls			ød1	
		min.	max.										
SF12- DRC080M-5	●	7.94	8.49	12	104	59	53	43	45	16	WDRC8 (WDRC17)	DC0794M-SC~DC0840M-SC	
	●	8.50	8.99		107	62	56	45				DC0850M-SC~DC0890M-SC	
	●	9.00	9.49		110	65	59	48				DC0900M-SC~DC0940M-SC	
	●	9.50	9.99		114	69	63	50				DC0950M-SC~DC0990M-SC	
SF16- DRC100M-5	●	10.00	10.49	16	120	72	66	53	48	20	WDRC10 (WDRC17)	DC1000M-SC~DC1040M-SC	
	●	10.50	10.99		123	75	69	55				DC1050M-SC~DC1090M-SC	
	●	11.00	11.49		126	78	72	58				DC1100M-SC~DC1140M-SC	
	●	11.50	11.99		129	81	75	60				DC1150M-SC~DC1190M-SC	
	●	12.00	12.49		132	84	78	63			WDRC12 (WDRC17)	DC1200M-SC~DC1240M-SC	
	●	12.50	12.99		135	87	81	65				DC1250M-SC~DC1290M-SC	
	●	13.00	13.49		138	90	84	68				DC1300M-SC~DC1340M-SC	
	●	13.50	13.99		142	94	88	70				DC1350M-SC~DC1390M-SC	
	●	14.00	14.49		145	97	91	73				WDRC14 (WDRC17)	DC1400M-SC~DC1440M-SC
	●	14.50	14.99		148	100	94	75					DC1450M-SC~DC1490M-SC
SF20- DRC150M-5	●	15.00	15.99	20	156	106	100	80	50	25	WDRC14 (WDRC17)	DC1500M-SC~DC1580M-SC	
	●	16.00	16.99		162	112	106	85				DC1600M-SC~DC1690M-SC	
	●	17.00	17.99		169	119	113	90				DC1700M-SC~DC1790M-SC	
SF25- DRC180M-5	●	18.00	18.99	25	181	125	119	95	56	32	WDRC17	DC1800M-SC~DC1890M-SC	
	●	19.00	19.99		187	131	125	100				DC1900M-SC~DC1990M-SC	
	●	20.00	20.99		193	137	131	105				DC2000M-SC~DC2099M-SC	
	●	21.00	21.99		200	144	138	110				DC2100M-SC~DC2150M-SC	
	●	22.00	22.99		206	150	144	115				DC2200M-SC~DC2250M-SC	
	●	23.00	23.99		212	156	150	120				DC2300M-SC~DC2350M-SC	
	●	24.00	24.99		218	162	156	125				DC2400M-SC~DC2450M-SC	
	●	25.00	25.50		225	169	163	130				DC2500M-SC~DC2550M-SC	

●:標準在庫 ●:Std stock

SF-DRC型(加工深さ Cutting Depth:8×D)

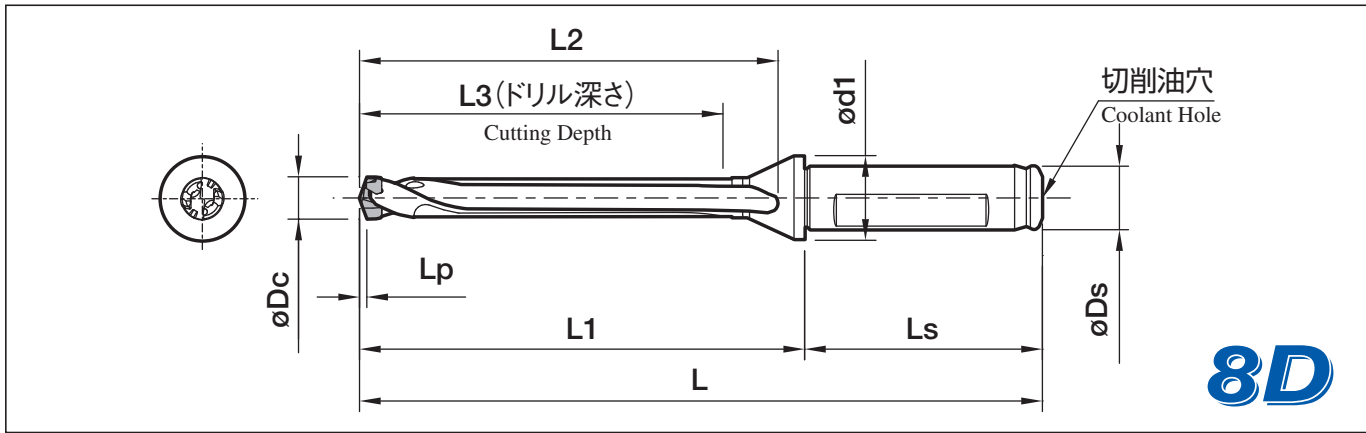



・Lp 寸法はチップ先端からコーナまでの距離を示す ● P3 ~ P5 参照 Lp indicates distance from drill point to corner edge ● See P3-P5

ホルダ寸法 Toolholder Dimension

型番 Description	在庫 stock	寸法(mm) Dimensions(mm)									部品 Spare Parts		適合チップ Applicable insert
		適合チップサイズ øDc Applicable Insert Dia.		øDs (h6)	L	L1	L2	L3	Ls	ød1	チップ交換レンチ Wrench ● P14参照 See P14		
		min.	max.										
SF12- DRC080M-8	●	7.94	8.49	12	129	84	79	68	45	16	WDRC8 (WDRC17)	DC0794M-SC~DC0840M-SC	
	●	8.50	8.99		134	89	83	72				DC0850M-SC~DC0890M-SC	
	●	9.00	9.49		138	93	88	76				DC0900M-SC~DC0940M-SC	
	●	9.50	9.99		144	99	93	80				DC0950M-SC~DC0990M-SC	
SF16- DRC100M-8	●	10.00	10.49	16	151	103	97	84	48	20	WDRC10 (WDRC17)	DC1000M-SC~DC1040M-SC	
	●	10.50	10.99		156	108	102	88				DC1050M-SC~DC1090M-SC	
	●	11.00	11.49		160	112	107	92				DC1100M-SC~DC1140M-SC	
	●	11.50	11.99		165	117	111	96				DC1150M-SC~DC1190M-SC	
	●	12.00	12.49		169	121	116	100			WDRC12 (WDRC17)	DC1200M-SC~DC1240M-SC	
	●	12.50	12.99		174	126	120	104				DC1250M-SC~DC1290M-SC	
	●	13.00	13.49		178	130	124	108				DC1300M-SC~DC1340M-SC	
	●	13.50	13.99		184	136	130	112				DC1350M-SC~DC1390M-SC	
	●	14.00	14.49		188	140	134	116				WDRC14 (WDRC17)	DC1400M-SC~DC1440M-SC
	●	14.50	14.99		193	145	139	120					DC1450M-SC~DC1490M-SC
SF20- DRC150M-8	●	15.00	15.99	20	204	154	148	128	50	25	WDRC14 (WDRC17)	DC1500M-SC~DC1580M-SC	
	●	16.00	16.99		213	163	157	136				DC1600M-SC~DC1690M-SC	
	●	17.00	17.99		223	173	167	144				DC1700M-SC~DC1790M-SC	
SF25- DRC180M-8	●	18.00	18.99	25	238	182	176	152	56	32	WDRC17	DC1800M-SC~DC1890M-SC	
	●	19.00	19.99		247	191	185	160				DC1900M-SC~DC1990M-SC	
	●	20.00	20.99		256	200	194	168				DC2000M-SC~DC2099M-SC	
	●	21.00	21.99		266	210	204	176				DC2100M-SC~DC2150M-SC	
	●	22.00	22.99		275	219	213	184				DC2200M-SC~DC2250M-SC	
	●	23.00	23.99		284	228	222	192				DC2300M-SC~DC2350M-SC	
	●	24.00	24.99		293	237	231	200				DC2400M-SC~DC2450M-SC	
	●	25.00	25.50		303	247	241	208				DC2500M-SC~DC2550M-SC	

●:標準在庫 ●:Std stock

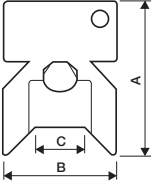
■ 部品(チップ交換レンチ) Wrench for changing insert

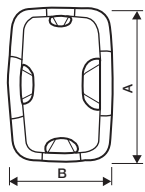
形状 Shape	型番 Description	寸法(mm) Dimensions(mm)			備考 Remarks
		A	B	C	
 	WDR C8	43	33	φ10.2	 <p>この部分に型番が記入されています Description is printed in this area.</p>
	WDR C10			φ12.2	
	WDR C12			φ14.2	
	WDR C14			φ17.2	
 	WDR C17	77	52	-	<p>・WDR C17(マルチタイプレンチ)には4ヶ所のチップ差込口があります。ご使用チップがDC1700M-SC~DC2099M-SCの場合、『φ17.00~φ20.99』と印字されたチップ差込口をご使用下さい。</p> <p>・WDR C17(Multiple type wrench) has four insert entry points. If using an insert ranging from DC1700M-SC to DC2099M-SC, use the entry point printed as "φ17.00~φ20.99".</p> <p>・WDR C17はWDR C8~14の代わりとしてご使用出来ます。WDR C17 can be used instead of WDR C8~14 wrench.</p>

■ DRC型マジックドリルのチップ交換方法 Method to change DRC type magicdrill insert

● チップ取付方法 How to attach inserts



- ① アーバにドリル本体を固定して下さい。チップの交換は、工作機械にアーバを取付けるか、ツールプリセッタ等に固定して行って下さい。
- ② エアを吹きつけてゴミなどを取り除いて下さい。
1) Fix drill holder on arbor. For insert exchange, fix arbor on the machine or set on toolpresetter.
2) Remove dust using air blow.



- ③ チップをホルダに差し込んで下さい。(手袋等の保護具をご使用下さい。)
3) Put into insert to holder.
(Use gloves to protect your hand from any danger.)

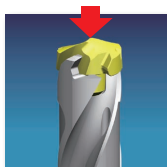

- ④ チップを軽く時計方向に回して下さい。(手袋等の保護具をご使用下さい。)
4) Turn lightly in a clockwise direction.
(Use gloves to protect your hand from any danger.)

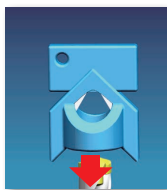

- ⑤ レンチを差し込みます。
5) Set the wrench properly.

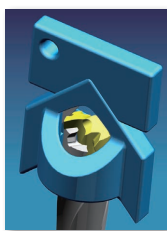

- ⑥ レンチがチップのレンチ用溝に噛み合っていることを確認下さい。
6) Make sure the wrench fits with insert's slot for the wrench.



- ⑦ ゆっくりレンチを回して下さい。
- ⑧ 装着完了。
7) Turn the wrench clockwise direction slowly.
8) Completed.

● チップ取外方法 How to detach inserts

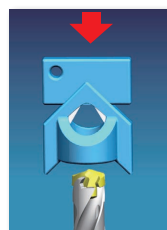

- ① チップにエアを吹付けて、ゴミなどを取除いて下さい。

- ② レンチを差し込みます。
1) Remove dust from insert using air blast.
2) Set the wrench properly



- ③ レンチをチップのレンチ用溝に噛み合わせて下さい。
3) Fit the wrench to insert slot for wrench.



- ④ レンチを反時計方向に回して下さい。
4) Turn the wrench counter clockwise direction.



- ⑤ ロックが外れると、チップは指で回ります。(手袋等の保護具をご使用下さい。)
5) Once lock is released, insert can be turned by fingers.
(Use gloves to protect your hand from any danger.)

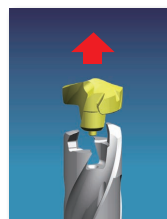

- ⑥ チップを抜いて下さい。(手袋等の保護具をご使用下さい。)
6) Remove insert.
(Use gloves to protect your hand from any danger.)

推奨切削条件 Recommended Cutting Condition

被削材 Workpiece Material	硬度 Hardness (HB)	切削条件 Cutting Condition		加工径 ϕD_c (mm) Cutting Dia. (mm)							備考 Remarks		
		切削速度 Cutting Speed Vc (m/min)	回転数 (min ⁻¹) Spindle Revolution 送り (mm/rev) Feed Rate	$\phi 8$	$\phi 10$	$\phi 12$	$\phi 14$	$\phi 16$	$\phi 18$	$\phi 20$		$\phi 25$	
													With Coolant
低炭素鋼 Low Carbon Steel	SS400 S10C~S25C	125	120 - 180	回転数 (min ⁻¹) 送り (mm/rev)	4,780 - 7,170 0.11 - 0.20	3,820 - 5,730 0.13 - 0.24	3,180 - 4,780 0.14 - 0.28	2,730 - 4,090 0.17 - 0.32	2,390 - 3,580 0.19 - 0.35	2,120 - 3,180 0.23 - 0.38	1,910 - 2,870 0.25 - 0.41	1,530 - 2,290 0.30 - 0.50	
炭素鋼 Carbon Steel	S30C~S58C (焼鈍 Annealed)	190	100 - 150	回転数 (min ⁻¹) 送り (mm/rev)	3,980 - 5,970 0.13 - 0.24	3,180 - 4,780 0.15 - 0.29	2,650 - 3,980 0.17 - 0.33	2,270 - 3,410 0.19 - 0.36	1,990 - 2,990 0.22 - 0.41	1,770 - 2,650 0.25 - 0.46	1,590 - 2,390 0.28 - 0.48	1,270 - 1,910 0.32 - 0.60	
				S30C~S58C (調質 Heat treated)	250	80 - 120	回転数 (min ⁻¹) 送り (mm/rev)	3,180 - 4,780 0.13 - 0.21	2,550 - 3,820 0.15 - 0.25	2,120 - 3,180 0.18 - 0.31	1,820 - 2,730 0.21 - 0.39	1,590 - 2,390 0.23 - 0.45	1,420 - 2,120 0.25 - 0.53
	300	50 - 75	回転数 (min ⁻¹) 送り (mm/rev)				1,990 - 2,990 0.11 - 0.19	1,590 - 2,390 0.12 - 0.23	1,330 - 1,990 0.16 - 0.28	1,140 - 1,710 0.21 - 0.32	1,000 - 1,490 0.23 - 0.35	880 - 1,330 0.25 - 0.41	800 - 1,190 0.28 - 0.41
			合金鋼 Alloy Steel	SCM, SCr等 (焼鈍 Annealed)	180	70 - 95	回転数 (min ⁻¹) 送り (mm/rev)	2,790 - 3,780 0.15 - 0.28	2,230 - 3,030 0.16 - 0.35	1,860 - 2,520 0.21 - 0.37	1,590 - 2,160 0.23 - 0.46	1,390 - 1,890 0.25 - 0.46	1,240 - 1,680 0.25 - 0.51
SCM, SCr等 (調質 Heat treated)	275	70 - 95					回転数 (min ⁻¹) 送り (mm/rev)	2,790 - 3,780 0.11 - 0.21	2,230 - 3,030 0.14 - 0.25	1,860 - 2,520 0.19 - 0.30	1,590 - 2,160 0.21 - 0.33	1,390 - 1,890 0.23 - 0.37	1,240 - 1,680 0.28 - 0.43
				300	60 - 90	回転数 (min ⁻¹) 送り (mm/rev)	2,390 - 3,580 0.11 - 0.19	1,910 - 2,870 0.12 - 0.23	1,590 - 2,390 0.16 - 0.26	1,360 - 2,050 0.18 - 0.31	1,190 - 1,790 0.21 - 0.33	1,060 - 1,590 0.23 - 0.36	960 - 1,430 0.25 - 0.38
350	50 - 75	回転数 (min ⁻¹) 送り (mm/rev)				1,990 - 2,990 0.11 - 0.20	1,590 - 2,390 0.12 - 0.23	1,330 - 1,990 0.16 - 0.25	1,140 - 1,710 0.17 - 0.29	1,000 - 1,490 0.18 - 0.32	880 - 1,330 0.20 - 0.36	800 - 1,190 0.23 - 0.38	640 - 960 0.28 - 0.50
		ステンレス鋼 Stainless Steel	SUS304 SUS316	220	60 - 80	回転数 (min ⁻¹) 送り (mm/rev)	2,390 - 3,180 0.11 - 0.19	1,910 - 2,550 0.12 - 0.23	1,590 - 2,120 0.16 - 0.26	1,360 - 1,820 0.18 - 0.31	1,190 - 1,590 0.21 - 0.33	1,060 - 1,420 0.23 - 0.36	960 - 1,270 0.25 - 0.38
SUS630	300					50 - 70	回転数 (min ⁻¹) 送り (mm/rev)	1,990 - 2,790 0.11 - 0.20	1,590 - 2,230 0.12 - 0.23	1,330 - 1,860 0.16 - 0.25	1,140 - 1,590 0.17 - 0.29	1,000 - 1,390 0.18 - 0.32	880 - 1,240 0.20 - 0.36
ねずみ鋳鉄 Gray Cast Iron	FC150~FC200	180	120 - 170	回転数 (min ⁻¹) 送り (mm/rev)	4,780 - 6,770 0.17 - 0.32	3,820 - 5,410 0.20 - 0.37	3,180 - 4,510 0.23 - 0.43	2,730 - 3,870 0.27 - 0.48	2,390 - 3,380 0.30 - 0.55	2,120 - 3,010 0.33 - 0.61	1,910 - 2,710 0.33 - 0.61	1,530 - 2,170 0.40 - 0.74	
				FC250~FC350	260	90 - 120	回転数 (min ⁻¹) 送り (mm/rev)	3,580 - 4,780 0.14 - 0.25	2,870 - 3,820 0.16 - 0.31	2,390 - 3,180 0.19 - 0.35	2,050 - 2,730 0.23 - 0.42	1,790 - 2,390 0.26 - 0.47	1,590 - 2,120 0.28 - 0.53
ダクタイル鋳鉄 Nodular Cast Iron	FCD400~FCD500	160	60 - 90	回転数 (min ⁻¹) 送り (mm/rev)	2,390 - 3,580 0.14 - 0.25	1,910 - 2,870 0.16 - 0.30	1,590 - 2,390 0.19 - 0.35	1,360 - 2,050 0.22 - 0.40	1,190 - 1,790 0.24 - 0.45	1,060 - 1,590 0.28 - 0.51	960 - 1,430 0.28 - 0.56	760 - 1,150 0.34 - 0.67	
				FCD600~FCD800	250	40 - 65	回転数 (min ⁻¹) 送り (mm/rev)	1,590 - 2,590 0.10 - 0.19	1,270 - 2,070 0.12 - 0.22	1,060 - 1,730 0.14 - 0.25	910 - 1,480 0.16 - 0.31	800 - 1,290 0.19 - 0.35	710 - 1,150 0.23 - 0.51

・ドリル全長が長くなる (3D → 5D → 8D タイプ) に従い、送りは推奨送り値の低目に設定して下さい。
As drill length is longer (3D → 5D → 8D type), please set feed rate lower than recommended rate.

特性グラフ The graph for features

<切削条件> : 被削材 調質鋼 Heat treated steel (硬度 Hardness 240HB) Vc=80m/min, Wet

●所要動力 Power required

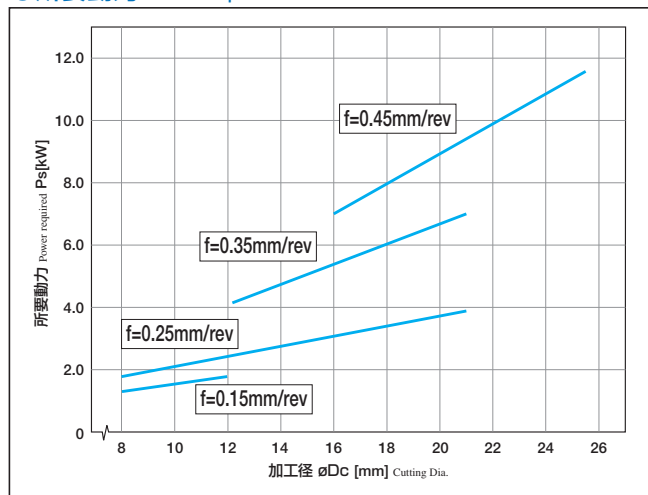

●トルク Torque

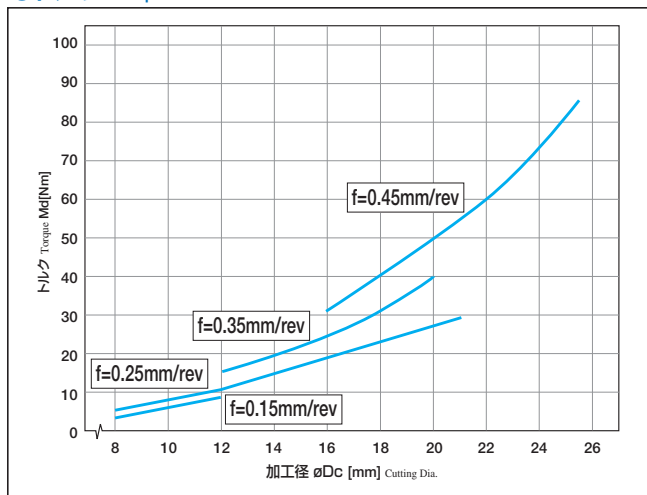

■ 切削液のご使用について Coolant

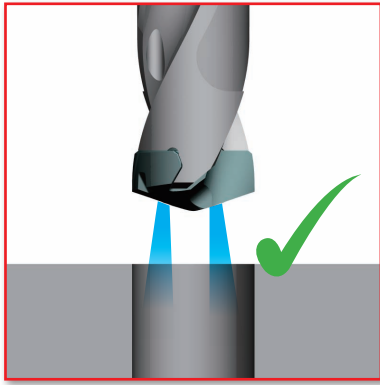

1) 内部給油を推奨します。
1) Internal coolant is recommended.

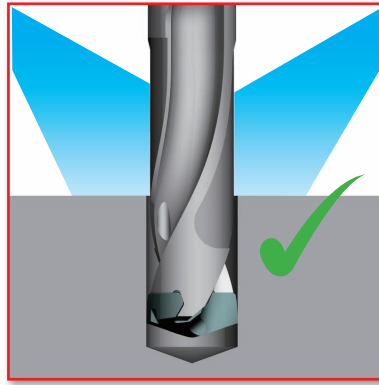

2) 外部給油の場合
2) In case of external coolant

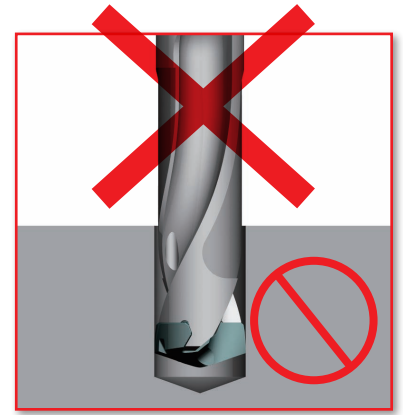

3) 乾式切削は推奨致しません。
3) Dry cutting is not recommended.

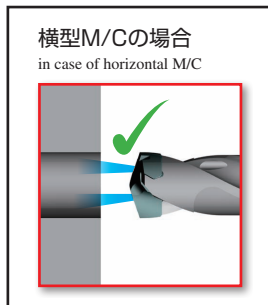

横型マシニングセンタ(横型M/C)では工具が回転する為、外部から切削液が入りにくくなりますので、内部給油でご使用下さい。
Please use internal coolant when horizontal machining center is used and this is because of rotation of tools inside and not enough coolant from outside.

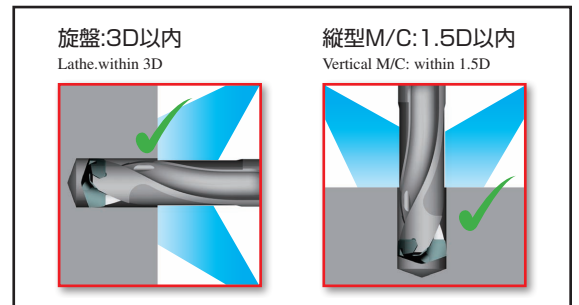

■ ご使用上の注意点 Usage Precautions

● 偏芯(芯ズレ)について Core Deviation

- 1) 旋削の場合
1) For Stationary

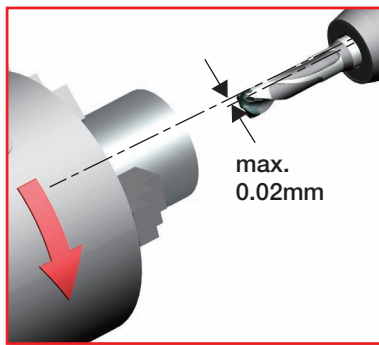

ボーリングスリーブ(ねじ止め)及びコレットチャック共にご使用出来ますが、ワークとドリルの偏芯量は、0.02mm以内にセットして下さい。
This is usable for boring sleeve (screw clamp) and collet-chuck, please be sure to set deviation amount under 0.02mm between workpiece and drill.

- 2) ミーリングの場合
2) For Rotating

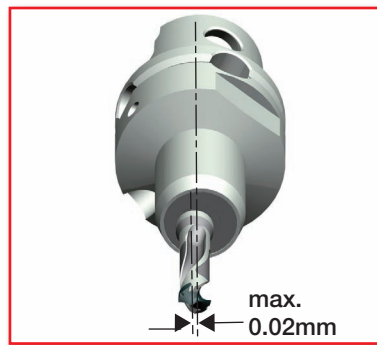

ドリル取付面の変形したアーバは使用しないで下さい。工作機械とドリルの芯ズレは、0.02mm以内にてご使用下さい。
Do not use any arbor which attachment surface is deformed. Center of arbor deviation have to be within 0.02mm

■ マシニングセンタへの取付け時の注意点 Cautionary reminder when installing parts to Machining Centers

DRC型マジックドリルの取付けは、To install DRC type magicdrill.

第1推奨 1st Recommendation … ハイドロチャック、パワーチャック、コレットチャック Please use Hydro-chuck, Power-chuck or Collet-chuck

第2推奨 2nd Recommendation … サイドロック方式アーバ Side-lock arbor



等にDRC型マジックドリルを取付けて下さい。
Please attach the DRC type magicdrill to one of these chucks.

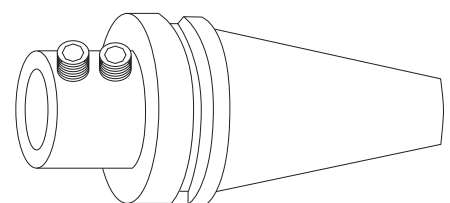

サイドロック方式アーバの例
Example of side-lock arbor

第1推奨
1st Recommendation

第2推奨
2nd Recommendation

S50C

<ul style="list-style-type: none"> ・フランジ Flange ・Vc=97m/min (n=2,490min⁻¹) ・H=32mm ・f=0.3mm/rev (Vf=747mm/min) ・湿式(内部給油) Wet (Internal Coolant) ・DC1250M-SC (PR0315) 	
SS14-DRC120M-3	3,000穴/チップ 3,000holes/insert
他社ドリル A Competitor A	1,800穴/ドリル 1,800holes/drill
・他社ドリルAに比べ、マジックドリルDRC型は、バリが減少し、10%以上の所要動力減少になった。工具寿命も大きく向上した。 ・Compared to competitor's drill A, MagicDrill DRC type has reduced burr and reduced more than 10% of the power required. Tool life has also improved greatly.	

(ユーザー様の評価による) Evaluation by the user

SCM440

<ul style="list-style-type: none"> ・ハウジング Housing ・Vc=83m/min (n=2,400min⁻¹) ・H=32mm ・f=0.24mm/rev (Vf=576mm/min) ・湿式(内部給油) Wet (Internal Coolant) ・DC1100M-SC (PR0315) 	
SS12-DRC110M-3	2,400穴/チップ more than 2,400holes/insert
他社PVD 超硬ソリッドドリル B Competitor B	2,000穴/ドリル 2,000holes/drill
・他社ソリッドドリルBに比べマジックドリルDRC型は、容易なインサート交換による段取り時間の大幅な削減ができた。 ・再研磨の為に予備工具費が削減でき、工具寿命も向上した。 ・Compared to competitor's solid drill B, MagicDrill DRC type has greatly reduced preparation time with its easy insert replacement feature. Also, the costs of spare tools for re-grinding has been reduced, and tool life has improved.	

(ユーザー様の評価による) Evaluation by the user

Q&A

Q-3 DRC(8Dタイプ)の深穴加工で、入り口側と奥側(出口側)の加工径にたわみと思われる寸法変動が発生しています。何か抑制する方法はありませんか？

For deep hole machining of DRC (8D type), there seems dimension variation something like deflection at entrance and its inside of drill dia. Is there any restraint method?

A-3 ドリルのたわみ(食い付きを良くする)を抑制する方法として、以下のような対策が有ります。
in order to restraint drill deflection (for better bite), there are some method as below.

対策1 Counter measure 1

● 送りをアップする increase feed rate

送りをアップすることで、加工径が安定する場合があります。
(送りアップの目安は、現行送り+0.03~0.05mm/rev)

by increase feed rate, cutting dia should be stabilized.
(Guide of increasing feed rate is current feed rate+0.03~0.05mm/rev)

<切削条件> Cutting Conditions
 S55C Vc=80m/min H=112mm
 f=0.25mm/rev → 0.30mm/rev にアップ
 f=0.25mm/rev → 0.30mm/rev
 WET(内部給油) WET (internal coolant)
 SS16-DRC140M-8
 DC1400M-SC(PRO315)

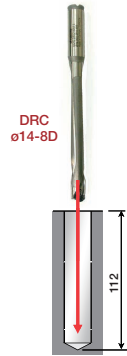
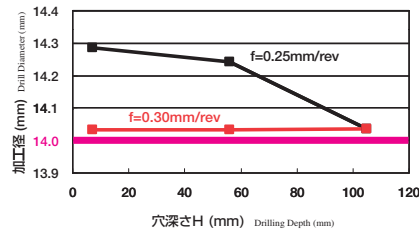

もしマシン剛性やクランプ剛性が弱い等の理由で、現状以上に送りが上げられない場合
in case of being not able to increase feed rate, If machine rigidity or clamping rigidity is weak,

対策2 Counter measure 2

センタ穴を開けて、加工径を安定させる方法 Method to stabilize by centering hole to check over the issue

1) 市販の頂角が140°近辺のタイプのセンタドリルか、DRC型ドリルを利用してセンタ穴を開ける。

1) Use top able 140°center drill or DRC type drill for hole making

(センタドリルに追加加工が出来る場合は、頂角を140°より大きくして下さい。)

(If additional process is possible for center drill, please be sure to maintain top able larger than 140°)

2) その後、DRC型ドリル(8Dタイプ)で加工する。

2) thereafter drill by DRC type (8D type)

<切削条件> Cutting Conditions
 S55C Vc=80m/min
 f=0.25mm/rev H=112mm
 WET(内部給油) WET (internal coolant)
 SS16-DRC140M-3
 SS16-DRC140M-8
 DC1400M-SC(PRO315)

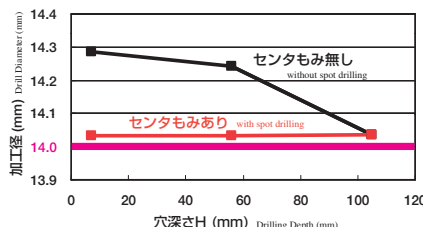

<センタもみ無し>
without spot drilling

<センタもみあり>
with spot drilling

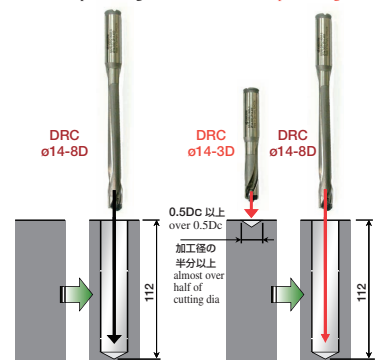

加工精度比較 Comparison of cutting precious

切削条件と測定位置 Cutting condition and measurement location

<切削条件> Cutting Conditions

被削材 Workpiece Material	S45C
Vc (m/min)	100
f (mm/rev)	0.2mm/rev, 0.3mm/rev
穴深さ H (mm) Drilling Depth	貫通穴(40mm) Penetrated hole (40mm)
切削液 Coolant	WET(内部給油) WET (internal coolant)
使用工具 Used tool	φ14 x 3Dタイプ 14Diamm x 3D type
マシン Machine	M/C

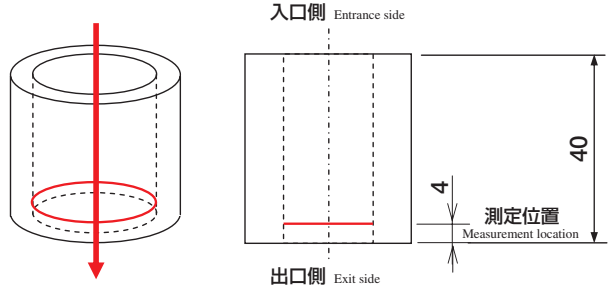

加工径 (f=0.3mm/revの場合) Cutting Dia (f=0.3mm/rev)

1) 刃先交換式ドリルとの比較

1) Comparison of indexable insert drill

刃先交換式ドリル Indexable insert drill	
●	Kyocera
■	F社 Comp.F

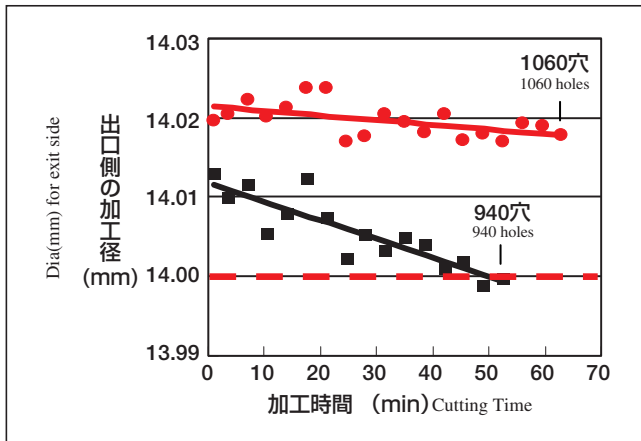

2) 超硬ソリッドドリルとの比較

2) Comparison of carbide solid drill

刃先交換式ドリル Indexable insert drill	超硬ソリッドドリル Carbide Solid Drill
●	Kyocera
	◆ C社 Comp.C
	▲ B社 Comp.B
	■ N社 Comp.N

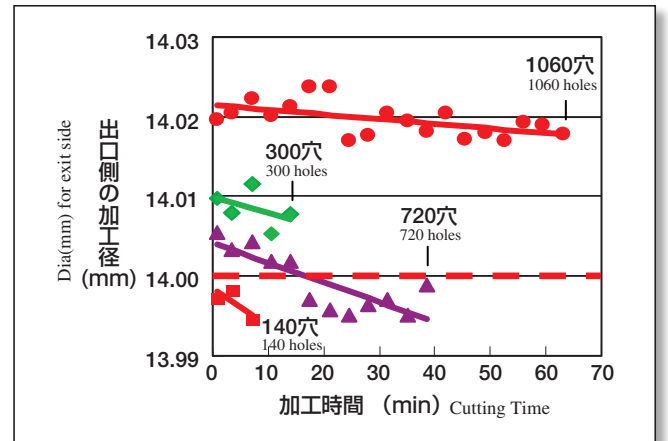

真円度 Roundness





1) 真円度 (f=0.2mm/rev の場合) 1) Roundness (f=0.2mm/rev)

刃先交換式ドリル Indexable insert drill		超硬ソリッドドリル Carbide Solid Drill		
Kyocera	F社 Comp.F	B社 Comp.B	C社 Comp.C	N社 Comp.N
真円度 (Roundness) :5.5μm	真円度 (Roundness) :22.5μm	真円度 (Roundness) :6.4μm	真円度 (Roundness) :9.8μm	真円度 (Roundness) :5.2μm

2) 真円度 (f=0.3mm/rev の場合) 2) Roundness (f=0.3mm/rev)

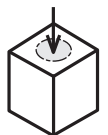
刃先交換式ドリル Indexable insert drill		超硬ソリッドドリル Carbide Solid Drill		
Kyocera	F社 Comp.F	B社 Comp.B	C社 Comp.C	N社 Comp.N
真円度 (Roundness) :10.7μm	真円度 (Roundness) :15.2μm	真円度 (Roundness) :12.0μm	真円度 (Roundness) :11.8μm	真円度 (Roundness) :12.3μm

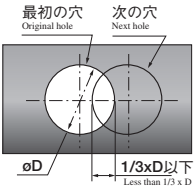
■適合ワーク形状 Applicable workpiece

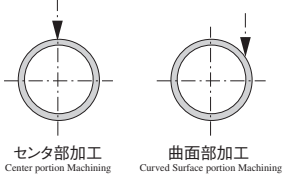
加工内容 Application	ワーク形状 Workpiece Shape	加工時の注意点 Caution for machining	
平面穴 Flat Face		1. SS400などの軟鋼加工では切くず処理が良好な ので、ステップ加工は不要です。 2. SUS304加工時、穴深さ2.5D以上ではステップ 加工を行って下さい。 3. スムースに切くず排出を行う為に、内部給油を推奨 致します。	1. Due to good chip control, step machining is not necessary for soft steel like SS400. 2. When machining SUS304, for hole depths of more than 2.5D, utilize the step machining process. 3. In order to have smooth chip removal, we recommend internal coolant.
重ね板 Stacked Plates		1. 重ね板が加工中にズレない様に固定して下さい。	1. Fix stacked plates not to slippage during machining.
半穴連続 Hole Expansion		1. オーバーラップ量が $1/3 \times D$ 以下であれば、加工 可能です。 	1. If the overlap amount is less than $1/3 \times D$, machining is possible.
くぼみ面穴 Concave Surface		1. くぼみ面穴加工は断続加工のため、送りを連続穴加 工時の半分以下にして下さい。	1. Concave surface holes are machined intermittently, so please set the feed rate at half or less of continuous hole machining.
パイプ外周穴 Pipe Material		1. パイプのセンタライン上の穴加工は可能です。 2. 曲面部分の加工には推奨致しません。 	1. Hole machining above the centerline of the pipe is possible. 2. Do not machine on curved surface areas.

■推奨しないワーク形状 Not recommended workpieces

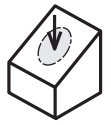
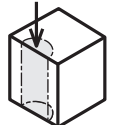
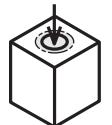
加工内容 Application	ワーク形状 Workpiece Shape	加工内容 Application	ワーク形状 Workpiece Shape	加工内容 Application	ワーク形状 Workpiece Shape
斜面穴 Slanted Surface		半割面 Half Cylindrical		下穴付き Cored Hole	

2つのiPhone用アプリで、お客様の生産性を向上します



切削条件計算機

ミーリング、ドリル、旋削に関する計算
 のお手伝い。
 加工時間も導く事ができるので、タクト
 タイムの算出にもお役にください。



他社型番対照表

他社材種、ブレード型番から京セラ
 該当品を簡単に導けます。
 異なる切削条件にも適合した検索
 結果を得る事ができます。

アプリは無料です

App Storeでゲット!!

App Storeで「京セラ」と検索し
 該当のアプリを入手してください。
 ※App Storeは米国apple, inc. 登録商標です。
 ※iPadでもお使い頂けます。

京セラのウェブサイト
 で最新の情報を
 ご覧いただけます

京セラ 工具

検索

<http://www.kyocera.co.jp/prdct/tool/index.html>

切削工具に関する技術的なご相談は

0120-39-6369

(携帯・PHSからもご利用できます) FAX:075-602-0335 京セラ カスタマーサポートセンター

●受付時間 9:00~12:00・13:00~17:00

●土曜・日曜・祝日・会社休日は受付していません

※個人情報の利用…お問合せの回答やサービス向上、情報提供に使用いたします。
 ※お問合せの際は、番号をお間違えないようお願い申し上げます。



京セラ株式会社

機械工具事業本部

〒612-8501 京都市伏見区竹田鳥羽殿町6番地
 TEL:075-604-3651 FAX:075-604-3472